



Exhibit
Display
Truss

TRUSSES
Truss and accessories

Exhibit and Display Truss.com

Tel: 905-509-0331 Fax: 905-509-0476 info@exhibitanddisplaytruss.com

Exhibit and Display Truss / "ED Truss" is a lightweight structural modular aluminum truss system. It's portability and durability make ED Truss ideal for trade show booths, exhibits, displays and many lighting and staging applications.

ED Truss is available in 2 Chord / Ladder, 3 Chord / Triangle and 4 Chord / Box configurations, in a variety of sizes.

2" (50 mm) OD X .065" (1.6 mm) WALL WITH 1/2" (12.7 mm) WEBBING

LADDER TRUSS (2 Chord)

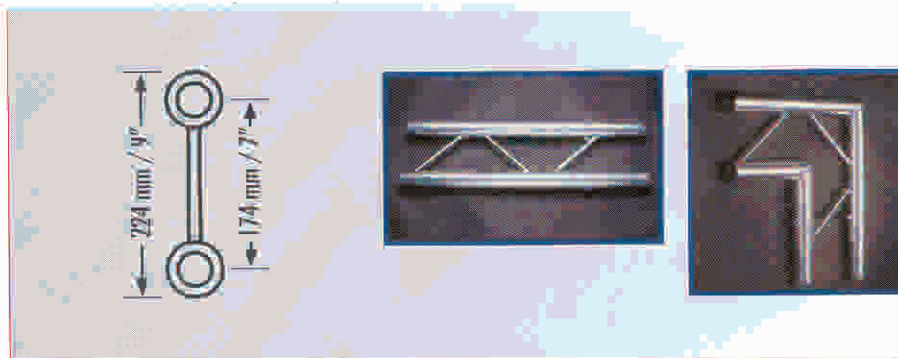

TRIANGULAR TRUSS (3 Chord)

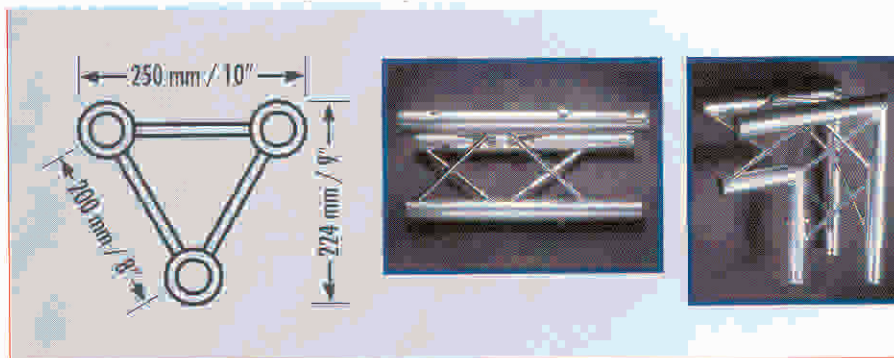

BOX TRUSS (4 Chord)

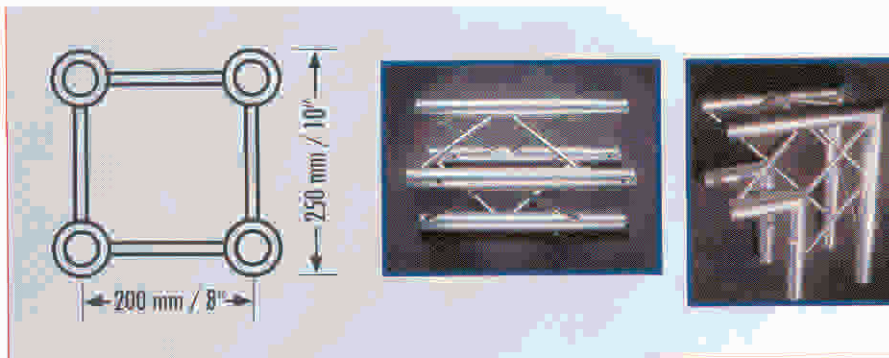

2" Trusses are stacked in 0.2 meter / 8" increments, however, can be manufactured to any specified length.

Corners add: 400 mm / 16"
T junctions add: 550 mm / 21 3/4"

**1" (25 mm) OD X .079" (2 mm)
WALL WITH 5/6" (8 mm) WEBBING**

6" TRUSS (Outside Dimensions)

TRIANGULAR



BOX

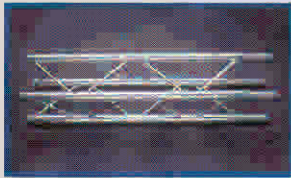

CORNER



Corners add: 305 mm / 12"
T junctions add: 457 mm / 18"

9" TRUSS (Outside Dimensions)

LADDER TRUSS (2 Chord)

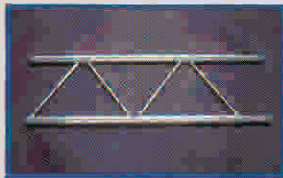

TRIANGULAR TRUSS (3 Chord)

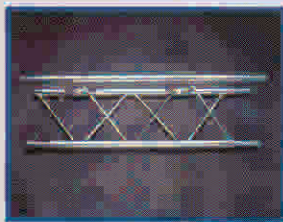

BOX TRUSS (4 Chord)

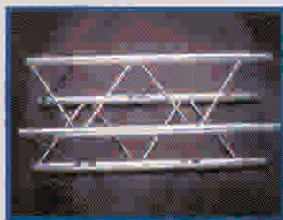
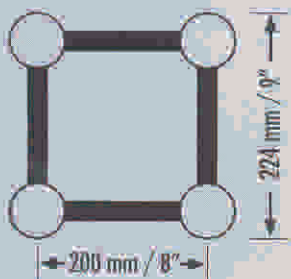

1" Trusses are stocked in 0.15 meter / 6" increments, however, can be manufactured to any specified length.

Corners add: 457 mm / 18"
T junctions add: 610 mm / 24"

6" • 9" TRUSS (outside dimensions)

Triangular truss junctions

(3 chord)

2 WAY (2W)

(90°*) 3 90 2W



(90°**) 3 90 2W



(120°) 3 120 2W

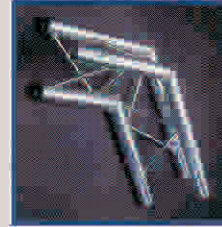

(135°) 3 135 2W



3 WAY (3W)

(Tvert) 3 T 3W v



(Thorz) 3 T 3W h



(120°) 3 120 3W



(135°) 3 135 3W



(90° Left) 3 90 3W L



(90° Right) 3 90 3W R



4 WAY (4W)

(90° Left) 3 90 4W L

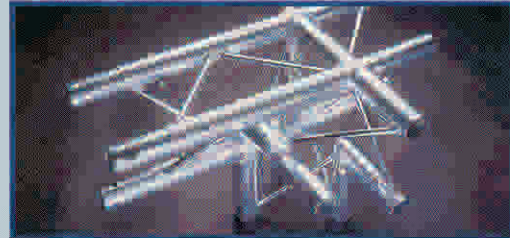

(90° Right) 3 90 4W R



TRIANGULAR TRUSS ORIENTATION



Apex Up™



Apex In™



Rotated 90°™



Rotated 90°™



LADDER TRUSS JUNCTIONS (2 CHORD)

2 WAY (2W)

(90°) 2 90 2W



(120°) 2 120 2W



(135°) 2 135 2W

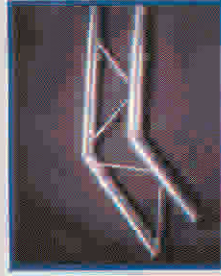

(150°) 2 150 2W

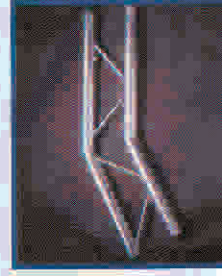

3 WAY (3W)

(I) 2 T 3W

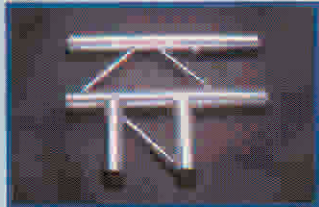

(90°) 2 90 3W



4 WAY (4W)

(90°) 2 T 4W



BOX TRUSS JUNCTIONS (4 CHORD)

2 WAY (2W)

(90°) 4 90 2W



(120°) 4 120 2W

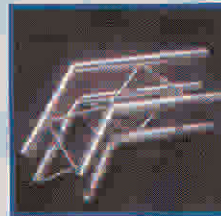

(135°) 4 135 2W

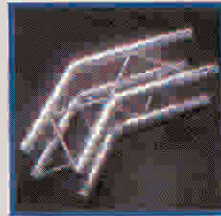

(150°) 4 150 2W

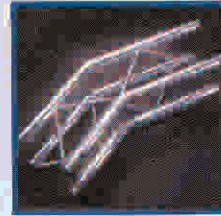

3 WAY (3W)

(I) 4 T 3W

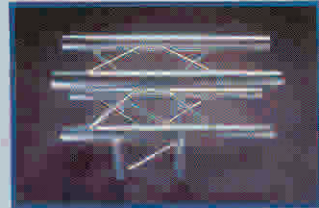

(90°) 4 90 3W

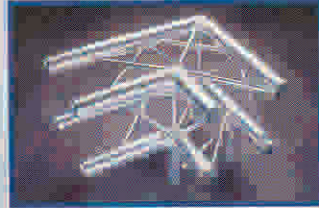

4 WAY (4W)

(90°) 4 90 4W



JUNCTIONS
LESS
THAN 90
DEGREES

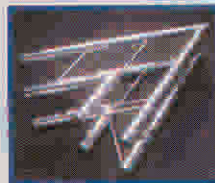

2° TRUSS CORNERS ADD : 800 MM / 31 1/2"

Junction Angle	Polygon Configuration
45	Right Angle Triangle
60	Equilateral Triangle
120	Hexagon
135	Octagon
150	12-Sided Polygon

A truss has two elements - the longitudinal member or chord, and the cross member or web. The combination of chords and webs provides load bearing capability over long free spans and enables

ED Truss to provide a reliable foundation for displays while maintaining a visually appealing sense of openness.

The 2 and 3 chord trusses will provide the load bearing performance indicated in the accompanying charts. The 3 chord truss provides greatly increased load bearing capacity without a proportional increase in weight over the 2 chord truss.

2" TUBE - LADDER TRUSS (2 CHORD)

Length		Point Load ² lb.	UDL ³ lb./ft.	Weight lb.
m.	in.			
0.6	24	—	—	4
1.0	39	930	345	5
2.0	78	790	145	8
3.0	118	720	87	12
4.0	157	685	64	15
5.0	197	650	46	18
6.0	236	575	36	21
7.0	276	505	32	24
8.0	315	430	26	28

Used in the upright mode

¹ Point Load - Center point load on the truss

2" TUBE - TRIANGULAR TRUSS (3 CHORD)

Length		Point Load ² lb.	UDL ³ lb./ft.	Weight lb.
m.	in.			
0.6	24	—	—	6
1.0	39	1840	775	8
2.0	78	1600	310	14
3.0	118	1440	168	20
4.0	157	1080	122	26
5.0	197	865	86	33
6.0	236	720	58	39
7.0	276	575	43	44
8.0	315	520	32	49

Box Truss load ratings are 30% greater than triangular truss ratings

³ UDL - Uniformly distributed load along the truss.

1" TUBE - LOAD INFORMATION

Outside Dimension	Triangular Truss	Box Truss
6"	15%	20%
9"	25%	30%

Percentages are based on the 2" triangular truss loads above

CURVES



Both the 2" and 1" trusses in ladder, triangular, and box can be curved to suit a variety of applications.

CUSTOM SIZES



Trusses can also be manufactured in many custom sizes.

CONNECTION SYSTEM (FOR EASE INSTALLATION)

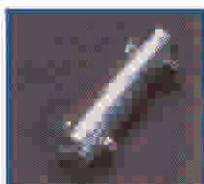

The 2" truss systems are connected with an 8" sleeve (insert) which is attached with M10 bolts and nylocks.

INSERT

For installation use 1 1/8" wrenches.

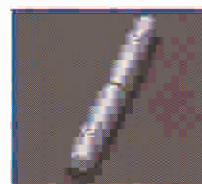

The 1" truss systems are connected with an expansion insert, which is attached with 1/4" screws.

EXPANSION INSERT

For installation use 1/8" allen key.

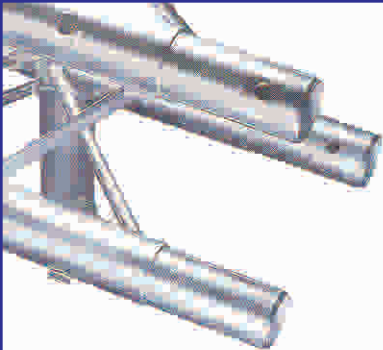

2" TUBE

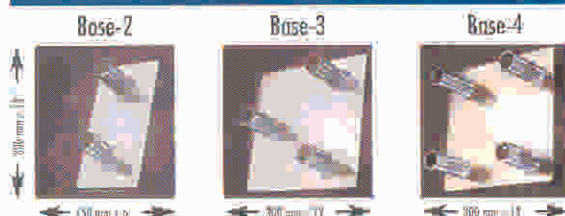

1" TUBE (9")

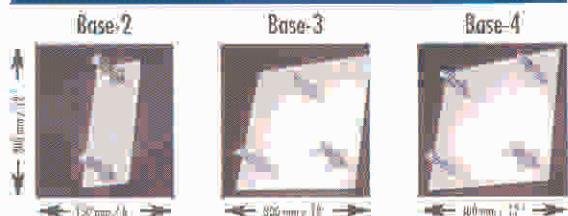

1" TUBE (6")



Base Plates - Base plates are commonly used at the bottom of a leg of truss to increase stability, as well as to secure trusses to a wide variety of surfaces.



CUSTOM BASE PLATES

Custom triangular and circular base plates are available.

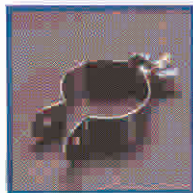

GRAPHIC CLIP

Stainless steel clips are available for attaching graphic panels, signage, or small lighting fixtures to the truss.



REINFORCING COLLAR

These are welded to ends of the tubes to supply additional reinforcing.



EXTENDER

A set of swivel castings are used to connect different cross sections of truss (example ladder truss to triangular truss)



END CAPS

Black plastic end caps are used to finish off all trusses.



BRACES

Outside braces add additional stability to a truss structure.

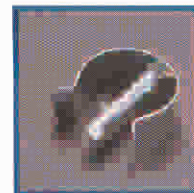

QUICK CLIP

A quick release clip can be used to replace the nut and bolt assembly to facilitate quick installation and dismantling.



BRACES

Inside braces can be used to increase structural rigidity, or to accommodate the mounting of graphics panels